

Ergotron® DS400 Series

freestanding module

Highlights

- Easily position the height and angle of your monitor for maximum comfort and productivity
- 180° monitor tilt
- 90° of side-to-side monitor rotation
- Handles monitors up to 20 lbs (9 kgs)
- 360° portrait/landscape screen adjustment
- Internal cable management conceals and routes cables
- Four points of adjustment for maximum adjustability
- Patented friction system provides smooth adjustment while maintaining touch-screen stability without the need for knobs or levers
- Internal steel construction ensures long-lasting durability
- Sleek, durable, easy-to-clean plastic exterior
- VESA® Flat Display Mounting Interface (FDMI™) Standard compliant for easy monitor attachment
- 5-year warranty



The DS400 utilizes Ergotron's patented Monitor Suspension Technology. Users can swing, lift, tilt and turn their flat panel monitors for maximum efficiency and ergonomic comfort. Throughout its range of motion, touch-screen stability is maintained.

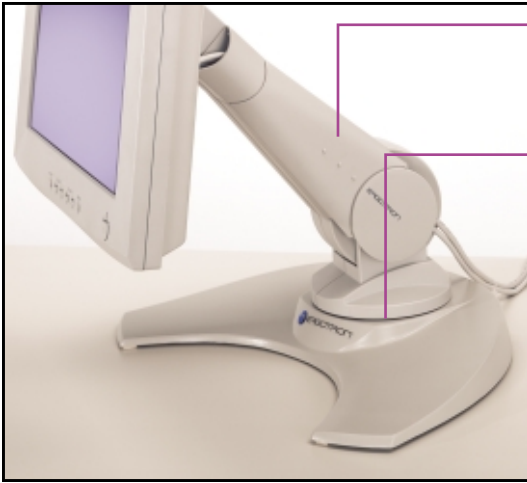

Up to 10.25" (260 mm) of vertical adjustability.

Rotate Arm up to 90°.

Range of Motion:

Vertical Adjustment: 90° (side view)

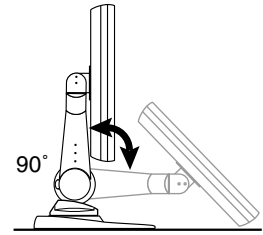

Side-to-Side Rotation: 90° (top view)

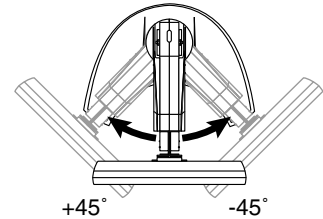

Monitor Tilt: 180° (side view)

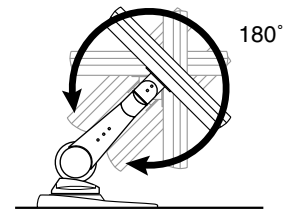

Portrait/Landscape Screen Adjustment: 360° (front view)

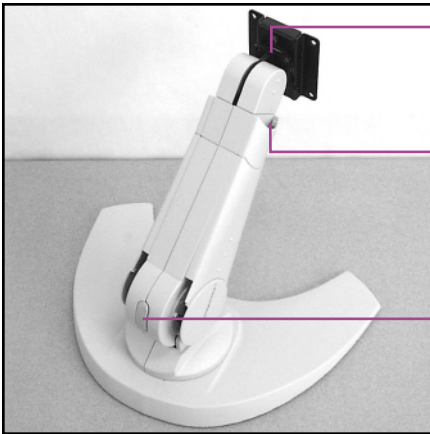
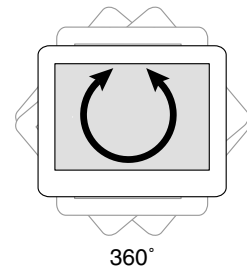

Pivot mechanisms, position monitor exactly where you need it.

Internal cable management system provides concealed, clean and organized installation.

Adjustable internal gas spring allows you to counterbalance your specific monitor.

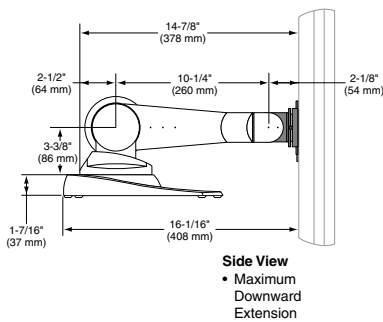

Basic Specifications:

Application Options: Horizontal Surfaces

Weight Capacity: 20 lbs (9 kg)

Monitor Interface Pad Options:

- VESA MIS-D, 100/75, C
- Custom Interface Plate (contact Ergotron for details and availability)

Colors: Available in black or grey

Accessory Options: Wrist Rests, Mouse Pads, Mouse Pouches, CPU Holders, Surge Suppressors and Power Strips

© 2003 Ergotron, Inc.
 rev. 01/27/2003 870-05-028

Ergotron, Inc.
 1181 Trapp Road
 St. Paul, MN 55121
 (800) 888-8458
 Fax (651) 681-7717
 www.ergotron.com
 sales@ergotron.com

Ergotron Europe
 Hogehilweg 8
 1101 CC Amsterdam ZO
 The Netherlands
 Tel. +31 20 312.29.39
 Fax. +31 20 312.29.40
 info.eu@ergotron.com

